



Ranch Hitch Adapter



MADE IN



U S A

INSTALLATION MANUAL



3100 – Straight Adapter



3139 – 8" Offset Adapter

Want to see a video of the install?

Use your SmartPhone to scan this QR Code and it will take you to our Installation Videos on the web.



ANDERSEN 
andersenhitches.com

**Toll Free
1-800-635-6106**

PARTS ILLUSTRATION

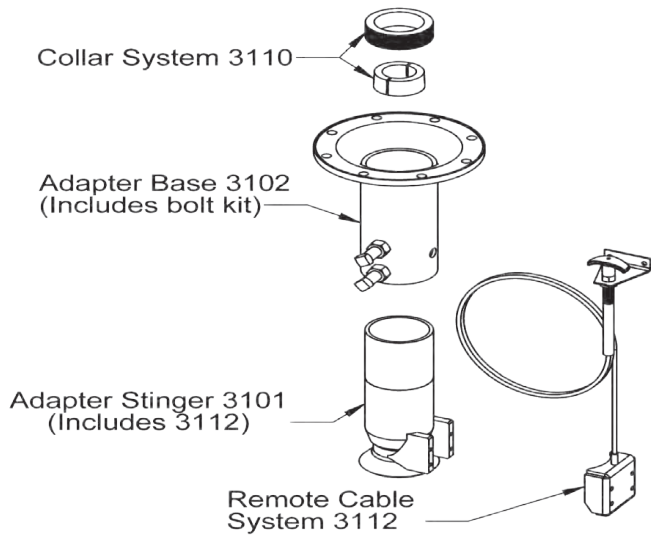

3100 – Straight Adapter

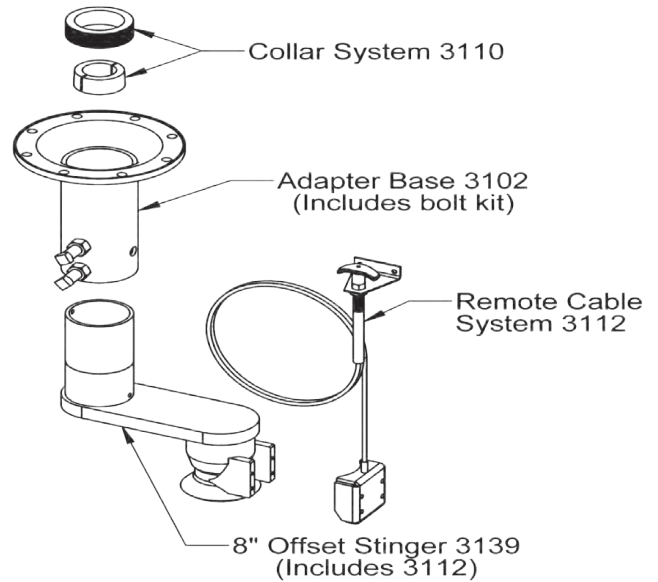

3139 – 8" Offset Adapter

PARTS LIST

- 1 Ranch Hitch Adapter Base
- 1 Ranch Hitch Adapter Assembly (includes stinger, base, cable, and cable bracket)
- 1 Threaded Collar Assembly (one threaded collar and two split collar halves)
- 2 Self drilling, self tapping screws
- 1 Safety Brake Cable Kit (quick release snap, 1/4" flat washers, two 1/4" nuts, 1 eye bolt)
- 1 Spanner Wrench
- 4 1/2" Grade 8 Bolts
- 4 1/2" Lock Washers
- 4 1/2" Grade 8 Nuts
- 2 Set Screws

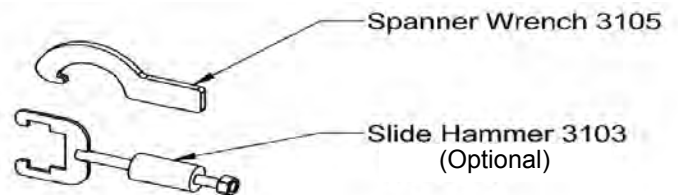

IMPORTANT SAFETY INFORMATION

Regularly check all hardware, bolts and nuts for wear and fatigue. Make sure that they are all properly tightened and secured in place.

NOTE: An installation video for the Ranch Hitch Adapter is available for viewing at www.AndersenHitches.com

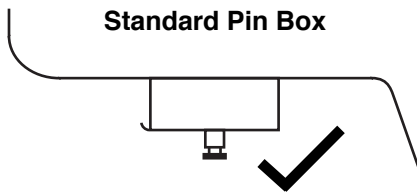

Standard Pin Box

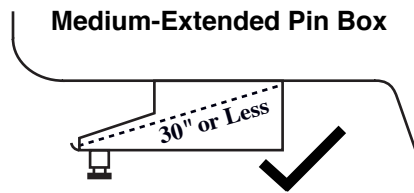

Medium-Extended Pin Box

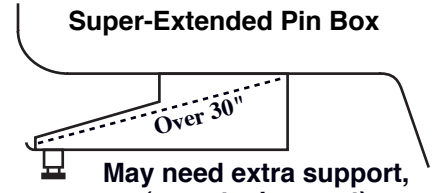

Super-Extended Pin Box

May need extra support,
(e.g. steel gusset)
-Call if unsure

INSTALLATION

1. Thoroughly inspect the trailer's pin box and frame for cracks or broken welds before installing the Ranch Hitch Adapter. Repair any problems before installation. On used trailers, inspect the king pin for wear and file any swaged metal round again or the Ranch Hitch split collar will not install properly. Use your good judgment in determining that the Ranch Hitch Adapter and the Trailer will work together to achieve the desired results (e.g. the heavier a trailer is, the shorter or stouter your pin box should be). Remove the plastic anti-friction plate if the trailer is equipped with one. It is important that the Ranch Hitch adapter base be mounted directly to the metal of the pin box.
2. Unpack the Ranch Hitch adapter box and make sure there are no missing parts by comparing items to the Parts List on page 2 in this manual. Contact your Authorized Andersen Dealer or Andersen's Customer Service Dept. if any parts are missing or damaged.
3. Locate the threaded collar and the split collets (2 pieces). The threaded collar is screwed into the black base at the factory to keep the threads from getting damaged in shipping. NOTE: The threaded collar and the split collets are each stamped with an 'x' on the bottom of the item. **Ensure that all x's point down when assembling because the threaded collar and split collets are tapered.**
4. Liberally apply anti-seize grease to the trailer king pin, the split collets, and the threaded collar. This will facilitate removal should you ever find the need (**see Figure 1**).
5. With the marked 'x' pointing down on each, slide the threaded collar over the king pin and while holding the collar up, place the split collets around the narrow neck of the king pin (**see Figures 2 and 3**). Slide the threaded collar down over the split collets and pull tight. You need to seat the threaded collar over the split collets with enough force that it does not want to slide up or spin when you thread the black base onto the threaded collar. You can accomplish this by using a gear puller to lightly seat the threaded collar onto the split collets (**see Figure 4**). One full turn from finger-tight is sufficient. If you will be installing these Ranch Hitch Adapters regularly (and we certainly hope you will,) you may wish to use our Slide Hammer #3103. It facilitates both installation AND removal of the Ranch Hitch (**see figure 5**).



FIGURE 1

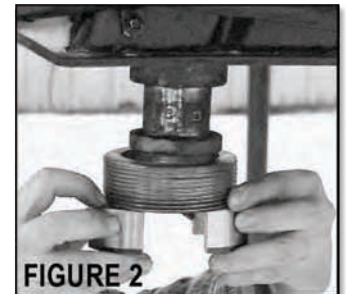

FIGURE 2

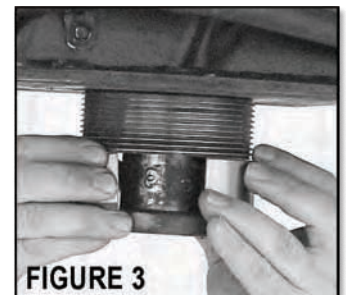

FIGURE 3

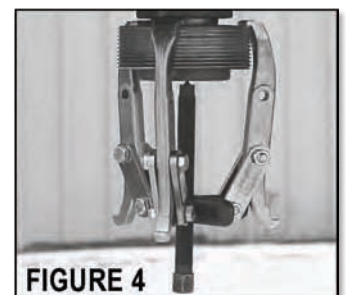
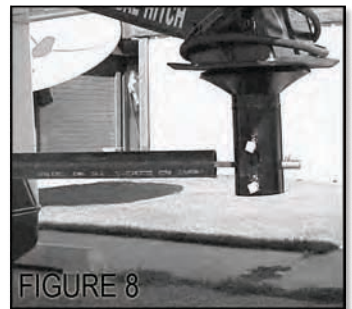
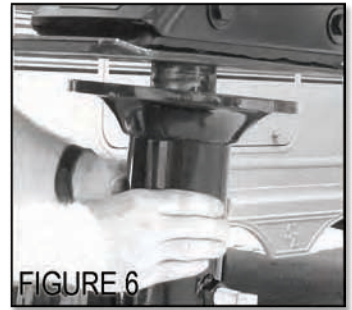

FIGURE 4



FIGURE 5

6. Locate the Ranch Hitch Adapter base and apply anti-seize grease to its inner threads. Thread it clockwise onto the seated collar, being careful not to cross-thread the base (**see figure 6**). Spin the base onto the collar –it should spin very easily– until the base contacts the bottom of the pin box. Inspect the base/pin box contact area and make sure the two touch each other without any gaps.
7. Locate the spanner wrench and a “cheater pipe” (not to exceed 4ft). Insert spanner wrench into the punched hole near the bottom of the base (**see figures 7 and 8**). Place cheater pipe over spanner wrench and tighten to 400 ft-lbs torque (this will be as much as two men can generate by pulling together on the end of your cheater pipe). This will finish seating the threaded collar onto the split collar and ensure a very strong grip on the king pin.
8. Locate the grade 8 bolts, lock washers and nuts. There are 8 holes drilled in the Ranch Hitch Adapter Base, but only four need to be used. You will be responsible to choose which 4 holes will be used to accept the Grade 8 Bolts; try to evenly spread the load as much as possible. Take care to locate the bolts where they will not interfere with any gusseting that might be inside the pin box. Drill the four holes. Insert the bolts into each hole and secure with a lock washer and nut. Tighten to 55 ft-lbs (**see Figures 13 and 14 on the following page**). Some pin boxes are enclosed and cannot be accessed for placement of the washers and nuts. In this case, or in any other application, the Grade 8 Bolts can be replaced by 4 one-inch tack welds placed by a certified welder. (**NOTE:** drilling and tapping the pin box metal to accept the grade 8 bolts will not offer sufficient strength and is not acceptable.)
9. Locate the stinger and remote cable assembly and the 2 set bolts. Place the stinger into the base and lightly tighten the set bolts enough to hold the stinger in place (**see Figure 9**). Note that the stinger tube has a scribed line or groove approximately half way up the tube. This line must not be visible when the stinger is in its final or lowest adjustment position in the base or there will not be sufficient stinger material inside the base for the set bolts to engage.
10. Back the tow vehicle under the trailer and determine the necessary position of the stinger to ensure the trailer is level and the overshoot has sufficient clearance from truck bed sideboards. If you are installing the #3100 Ranch Hitch Adapter, there is no proper position for the locking mechanism. If you are installing the #3139 8" offset Ranch Hitch Adapter, the extension needs to be carefully positioned parallel to the centerline of the trailer. When you have determined the final position of the Stinger, tighten the set bolts to 180 ft-lbs of torque (**see Figure 10**). (**NOTE:** The remote cable assembly is adjusted at the factory and should need no further adjustment to function properly).



11. Attach the remote cable bracket (the part with the T-handle on the end of the cable) and the 2 self tapping screws. Choose a location under the trailer overshoot that will allow the screws to penetrate the framing of your trailer. **(See Figure 12)**. DO NOT rely on only penetrating the trailer skin, or the cable handle will work free. We recommend you keep this mounting spot within 24 inches of the trailer centerline to assure that the bracket and T-handle have sufficient clearance from the tow vehicle side boards to avoid crushing them when on uneven terrain or when turning. Secure the handle bracket to the frame with the self tapping screws **(See Figure 11)**. Do not leave the remote cable assembly flopping loosely in your tow vehicle bed. It will inevitably get snagged on something and become damaged.

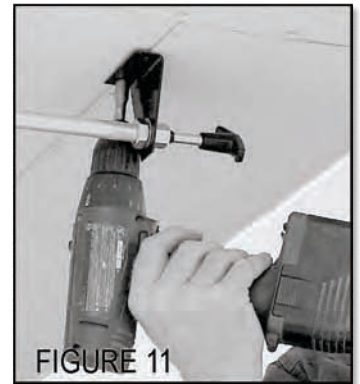

FIGURE 11

12. Locate the one 1/4" eye bolt, two flat washers, one 1/4" locking nut, and one quick release snap. Most 5th wheel trailers are equipped with break-away brakes. You will want to find a way to attach your trailer's break-away brake cable to your tow vehicle. A hardware package included with the Ranch Hitch Adapter can be used for this. First, install the eye bolt into one of the tow vehicle's stake pockets using an existing hole or by drilling your own. Make sure you put a flat washer on each side of the hole. Place the quick release snap on the end of the break-away brake cable and hook it into the eye bolt. (Do not forget to detach the cable when uncoupling the trailer from the tow vehicle.)

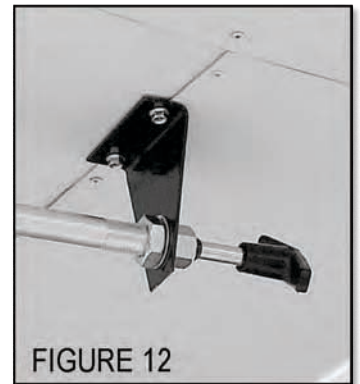

FIGURE 12

13. Make sure the Ranch Hitch Adapter coupler is open by twisting the T-handle counter-clockwise and pulling it out. Couple the trailer and the tow vehicle together and close the Ranch Hitch Adapter by pushing the T-handle in and turn clockwise 1/4 turn. Make sure the trailer and tow vehicle are coupled up by lifting the trailer with its jack to assure the Ranch Hitch Adapter has locked onto the tow ball. Connect the trailer break-away brake cable.

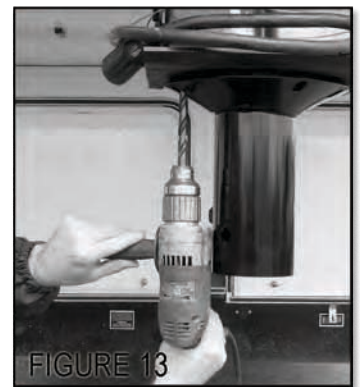

FIGURE 13

14. Because Andersen Manufacturing Inc. has no control of your trailers pin box and frame construction. We would ask you to use caution on your first towing experiences with the Ranch Hitch Adapter. Be aware of what your trailer is telling you. If you are feeling undue chocking, or if you feel significant surging when stopping or starting, additional reinforcing gussets may need to be positioned in or on your pin box. A good welder will be able to shore things up, and you will be safely on your way.



FIGURE 14

Some States require Safety Chains – Andersen's Heavy Duty Safety Chains (part #3109) will fulfill this requirement.



RANCH HITCH ADAPTER LIMITED WARRANTY

Andersen Manufacturing, an Idaho Corporation, having its principal place of business at 3125 N. Yellowstone Highway, Idaho Falls, Idaho 83401 ("Manufacturer") warrants its Ranch Hitch Adapter Product (the "products") for one year from the date of purchase as follows (Subject to the Conditions and Limitations listed herein):

Limited Warranty. Manufacturer warrants the Products sold hereunder will be free from defects in material, and workmanship when subject to normal and proper use for one year from date of purchase. If the Products do not conform to this Limited Warranty during the warranty period (as herein above specified), buyer shall notify Manufacturer in writing of the claimed defects and demonstrate to Manufacturer satisfaction that said defects are covered by this Limited Warranty. If the defects are properly reported to Manufacturer within the warranty period, and the defects are of such type and nature as to be covered by this warranty, Manufacturer shall at its own expense, furnish, replacement Products or, at Manufacturer's option, replacement parts for the defective Products. Removal, shipping and installation of the replacement Products or replacement parts shall be at Buyer's expense. The warranty card must be filled out and received by the manufacturer.

Other Limits. THE FOREGOING IS IN LIEU OF ALL OTHER WARRANTIES, EXPRESSED OR IMPLIED, INCLUDING BUT NOT LIMITED TO THE IMPLIED WARRANTIES OF MERCHANTABILITY AND FITNESS FOR A PARTICULAR PURPOSE. Manufacturer does not warrant against damages or defects arising out of improper or abnormal use of handling of the Products; against defects or damages arising from improper installation, including bolting the Ranch Hitch Adapter to the pin box as described in the instructions; against sudden impact arising from a collision of other abnormal occurrences; nor against any damage incurred to the trailer from the use of this adapter.

Since it is beyond the Manufacturer's control as to what trailers the Ranch Hitch Adapter may be installed on, and what condition the trailer frame or pin-box may be in, the Manufacturer will not warrant or assume liability for damages incurred. It has been the experience of the Manufacturer that if the trailer is a recently built model and the frame is in good condition, and the trailer brakes work properly, there should not be excess stress or damages to the frame. It is the responsibility of the purchaser to have the trailer braking system checked and maintained on a regular basis. The Manufacturer does not warrant against discontinuation of products, acts of God, defects in products or components not manufactured by Manufacturer, or against damages resulting from such non-Manufacturer made products or components. Manufacturer passes on to Buyer the warranty it received (if any) from the maker thereof of such non-Manufacturer made products or components. This warranty also does not apply to Products upon which repairs have been affected or attempted by persons other than pursuant to written authorization by Manufacturer. The weight ratings and certifications on the enclosed andersen hitch accessory is intended to represent only the product capability and in no way reflects the capacity or ratings of any towing system it is used with. In many cases, the rating of our hitch will be greater than those of the vehicle towing system, hitch, and trailer being used with our accessory. Manufacturer strongly advises the consumer and operator to learn the ratings of the various components of the towing system and to NOT exceed the limits of the lowest rated component.

Exclusive Obligation. THIS WARRANTY IS EXCLUSIVE. The sole and exclusive obligation of Manufacturer shall be to repair or replace the defective Products in the manner and for the period provided above. Manufacturer shall not have any other obligation with respect to the Products or any part thereof, whether based on contract, tort, strict liability or otherwise. It is understood the seller's liability, whether in contract, in tort, under any warranty, in negligence or otherwise, shall not exceed the return of the wholesale amount of the purchase price paid by the purchaser, Under no circumstances, whether based on this Limited Warranty or otherwise, shall Manufacturer be liable for incidental, special, or consequential damages. The price stated for the product is considered in limiting sellers liability.

Other Statements. Manufacturer's employees or representative's ORAL OR OTHER WRITTEN STATEMENTS DO NOT CONSTITUTE WARRANTIES, shall not be relied upon by Buyer, and are not a part of the contract for sale or this limited warranty. As mentioned above, Purchaser is responsible to maintenance checks on the braking system on a regular basis.

Entire Obligation. This non-Prorated Limited Warranty states the entire obligation of Manufacturer with respect to the Products. If any part of this Limited Warranty is determined to be void or illegal, the remainder shall remain in full force and effect. Notice of any warranty situation must be sent to Manufacturer by registered mail in writing and include a photograph of the defective or damaged part.

Return Merchandise Authorization (RMA) and warranty procedure may be obtained by visiting Andersen's website at www.andersenhitches.com and clicking on 'Return Policy' at the bottom of the page, or by calling our customer service department at 1-800-635-6106.

ANDERSEN

andersenhitches.com

Ranch Hitch Adapter
Warranty Registration and Validation System

* All information must be complete and sent to Andersen Mfg. Inc. to validate Warranty

Mail or fax this completed warranty to:

Andersen Mfg. Inc.
3125 N. Yellowstone Hwy
Idaho Falls, ID 83401

Fax: 1.208.523.6562

Installation Date: _____

Name: _____

Address: _____ City: _____ State: _____ Zip: _____

Phone: _____

Dealer: _____ Salesman: _____

Installer: _____

Customer Signature: _____
(upon approval of installation)



Tough. Innovative. Proven.

ANDERSEN



andersenhitches.com

See our full line of towing products at
www.AndersenHitches.com



*Aluminum Rapid Hitch
-The Original-*



*Silent, No-Sway, No-Bounce
Weight Distribution Hitch*



*EZ Adjust Hitch
(one pin does it all)*



*2" Adapter Sleeve
for 2-1/2" receivers*



*Ultimate 5th Wheel Connection
(Kingpin to Gooseneck ball)*



*Alumistinger
Ball Mounts (2"-10")*

Made in



USA



www.AndersenHitches.com • 1.800.635.6106