

Installation Instructions

Demco

Wireless CoachLink

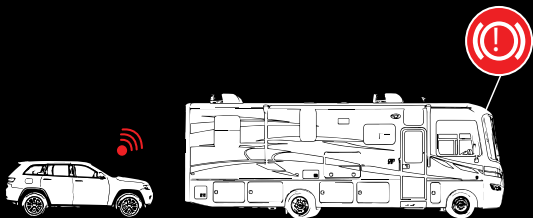

Works with all brands of braking systems!

Thank you for purchasing the Demco Wireless CoachLink System, and welcome to the Demco Family. Demco is a family owned and operated business that has been dedicated to creating a safe braking environment for all towed vehicles.

Your Wireless CoachLink System will give you the confidence that your braking system is functioning as designed from the driver's seat of your coach. This system is a perfect complement to the Air Force One or Stay In Play DUO. It can also be paired with any other braking system to bring assurance that it is braking properly.

We at Demco hope that this is only the beginning of the products we can offer to serve your towing needs. We take pride in caring for each customer, so if there is ever a question about our product please feel free to contact us by phone at 800-543-3626.

Sincerely,
The Demco Team

Refund Policy

Demco has a 30 day return policy on the original date of purchase. Items must have a Demco invoice with corresponding part number to be eligible for refund and are subject to the return authorization policy. All returns are subject to a variable restocking fee not to exceed 20% (not including missing components).

Limited One (1) Year Warranty

We are confident that our product will perform well and therefore warrant the original purchaser, that the new product will be free from mechanical and electrical defects in material and workmanship during the warranty period. The warranty period begins on the original purchase date. The warranty is for current production models and the original purchaser only. Demco does not warrant any part of the installation nor failure related to improper installation.

The Warranty Period

If, during the 12 months of the warranty period, your Demco product should be found defective, Demco will repair or replace the product at its discretion. Demco will refund to the original purchaser freight charges incurred in returning the product to the factory during this portion of the warranty period. (This does not include repackaging charges incurred to a third party) All warranty shipping & freight charges are for normal delivery, expedited freight charges are not included. Demco may choose, at its sole discretion, to allow usage of other new parts for the purpose of warranty repair. Such approval requires prior authorization and is subject to the return authorization policy.

Included in your CoachLink system:

Wireless Receiver:

Front



Power Indicator LED

Brakes Applied LED

Rear

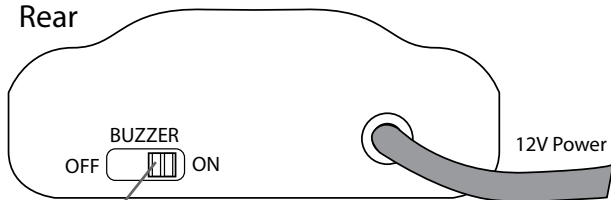

Buzzer ON/OFF (7 second delay)

Wireless Transmitter:

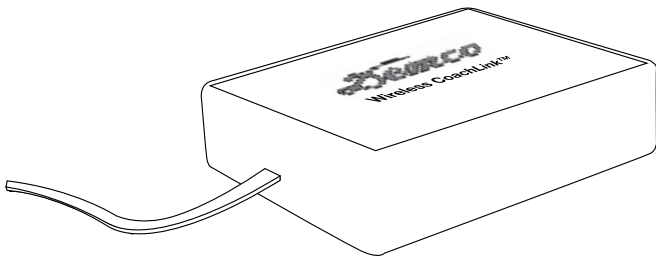

| ITEM | PART # | QTY | DESCRIPTION |
|------|--------|-----|-----------------------------------|
| 1 | 07378 | 2 | BUTT CONNECTOR 16-14 GA INSULATED |
| 2 | 16024 | 1 | T-TAP CONNECTOR |
| 3 | 01883 | 1 | WIRE SPLICER |
| 4 | 16028 | 1 | .25 MALE SPADE CONNECTOR |
| 5 | 05744 | 1 | TERMINAL RING |
| 6 | 16294 | 1 | VELCRO LOOP & HOOK |

Please order replacement parts by PART NO. and DESCRIPTION

STEP 1

Locate the CoachLink Transmitter in the towed vehicle:

For best results, locate the CoachLink Transmitter under the driver's side dash area.

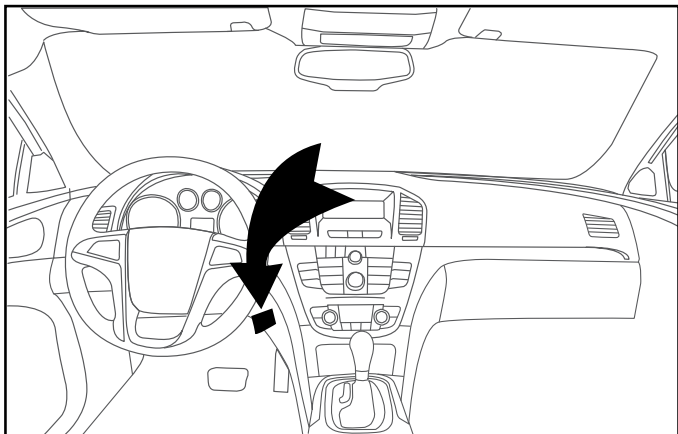

Secure the 900MHz transmitter in place using the provided hook and loop fastener.



STEP 2A



Wiring the CoachLink Transmitter for use with the Air Force One

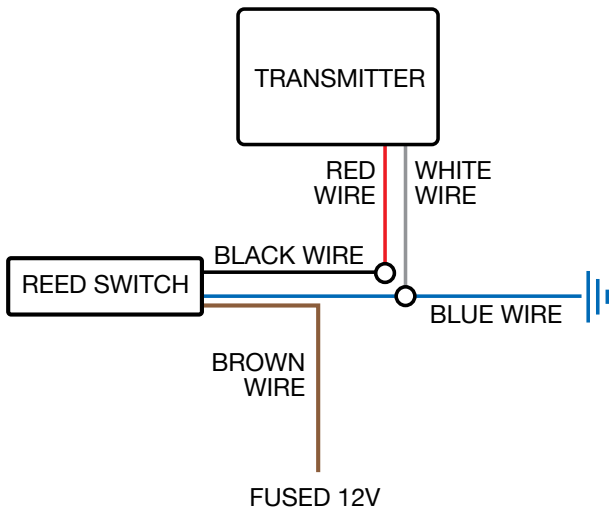

(For Air Force One Only)

Connect the red wire on the Wireless CoachLink Transmitter to the black wire on the reed switch.

Connect the white wire on the Wireless CoachLink Transmitter to the blue wire on the reed switch and to a suitable frame ground.

Note: If the battery is disconnected on the towed be sure to run the ground directly to the negative battery terminal.

Connect the brown wire on the reed switch to the breakaway fuse in the engine compartment of the towed vehicle.

STEP 2B



Wiring the CoachLink Transmitter for use with the Stay-in-Play DUO

Locate the cold side wire of the towed vehicle's brake light switch. This is the wire that is normally cold (unpowered), but activates 12 volts to the brake lights when the brake pedal is depressed.

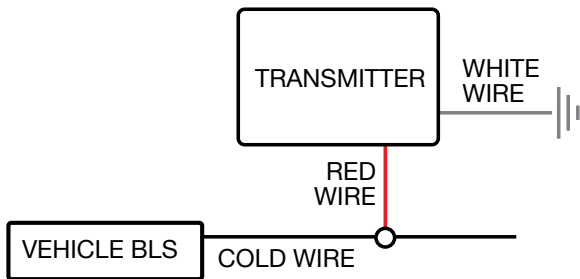

Note: If the vehicle has an inactive brake light switch, meaning the cold wire does not receive voltage when the key is in the tow position, connect the red wire to the blue wire on the DUO system.

(For the DUO only)

Insert the spade located on the red wire of the CoachLink Transmitter cable into the red flipover spade connector.

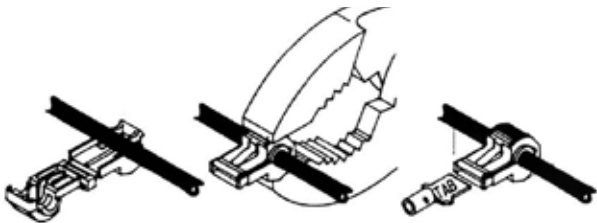

Using Pliers clip the red flipover spade connector over the cold side of the brake light switch. If your vehicle has an inactive brake light switch connect the red to the blue wire of the Stay N Play DUO operating unit that is under the hood of the towed vehicle.

Connect the white wire to the black wire of the G-Force Controller.

STEP 2c UNIVERSAL

Wiring the CoachLink Transmitter for universal applications

Locate the cold side wire of the towed vehicle's brake light switch. This is the wire that is normally cold (unpowered), but activates 12 volts to the brake lights when the brake pedal is depressed.

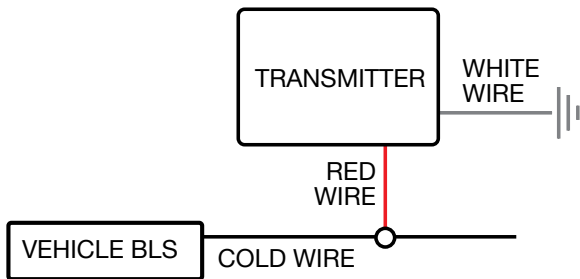

Note: If the vehicle has an inactive brake light switch, meaning the cold wire does not receive voltage when the key is in the tow position an add-on brake light switch will need to be installed separately.

Insert the spade located on the red wire of the CoachLink Transmitter cable into the red flipover spade connector.

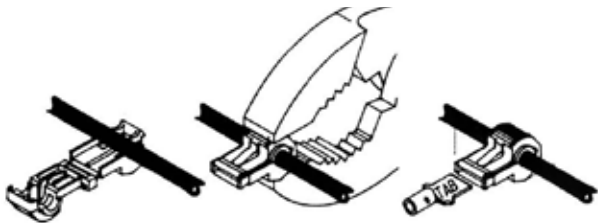

Using Pliers clip the red flipover spade connector over the cold side of the brake light switch. If your vehicle has an inactive brake light switch connect the red flipover spade connector to the cold side of the aftermarket brake light switch.

Connect the white wire to a suitable frame ground. If your vehicle requires a battery disconnect to tow, or if you are using an add-on brake light switch you must connect the white wire to the negative terminal of the towed vehicle's battery.

STEP 3

Install the CoachLink Receiver in the coach.

Set the CoachLink Receiver in a location that is easily viewable from the driver's seat of the coach.

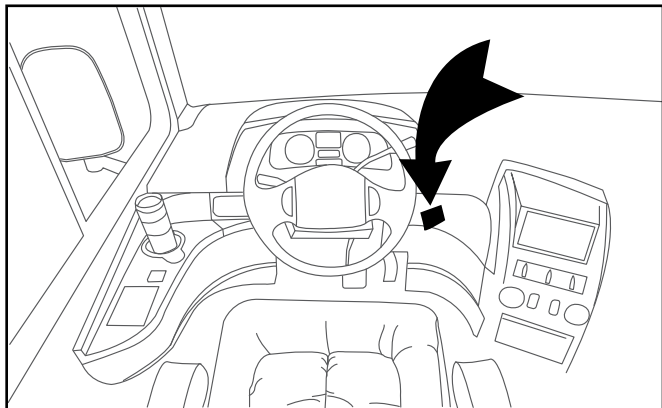

Plug the CoachLink Receiver in to an auxiliary 12v plug in the coach dash area.

STEP 4

Test the Installation

Locate the towed vehicle behind the coach as if it were going to be towed.

For Air Force One Installs:

Connect the Air Force One Airline between the towed and the coach and step on the brake pedal in the Coach and hold it down for 2-3 seconds.

For DUO Installs:

Turn the G-Force Controller switch to the “on” position and pull the breakaway pin from the switch located on the front of the towed vehicle

For other installs:

Step on the brake pedal in the towed vehicle

Verify that the “Brakes Applied” indicator is illuminated on the CoachLink Receiver.



FCC ID: QY4-618

"This device complies with Part 15 of the FCC Rules. Operation is subject to the following two conditions: (1) this device may not cause harmful interference, and (2) this device must accept any interference received, including interference that may cause undesired operation."

INSTRUCTION TO THE USER

Note: This equipment has been tested and found to comply with the limits for a Class B digital device, pursuant to part 15 of the FCC Rules.

These limits are designed to provide reasonable protection against harmful interference in a residential installation. This equipment generates,

uses and can radiate radio frequency energy and, if not installed and used in accordance with the instructions, may cause harmful interference

to radio communications. However, there is no guarantee that interference will not occur in a particular installation. If this equipment does

cause harmful interference to radio or television reception, which can be determined by turning the equipment off and on, the user is encouraged to try to correct the interference by one or more of the following measures:

—Connect the equipment into an outlet on a circuit different from that to which the equipment is connected.

—Consult an experienced radio/TV technician for help.

Changes or modifications not expressly approved by (end product company's Name) could void the user's authority to operate the equipment.



Demco

4010 320th St., BOYDEN, IA. 51234

PH: (712) 725-2311

FAX: (712) 725-2380

TOLL FREE: 1-800-54DEMCO (1-800-543-3626)

www.demco-products.com

Go online to www.demco-products.com for Demco warranty policies, operator manuals & product registration.