

DEMCO Model DA20 - 20,000 lb

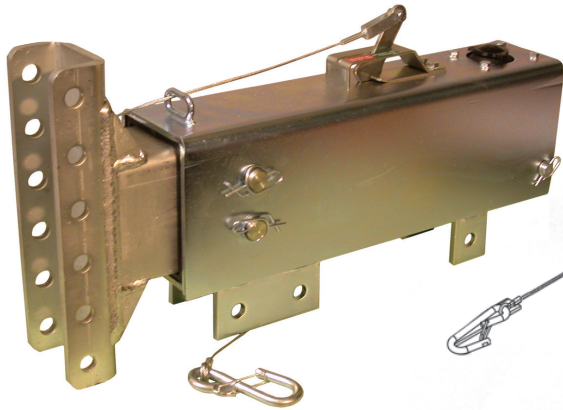

DA2002BZ

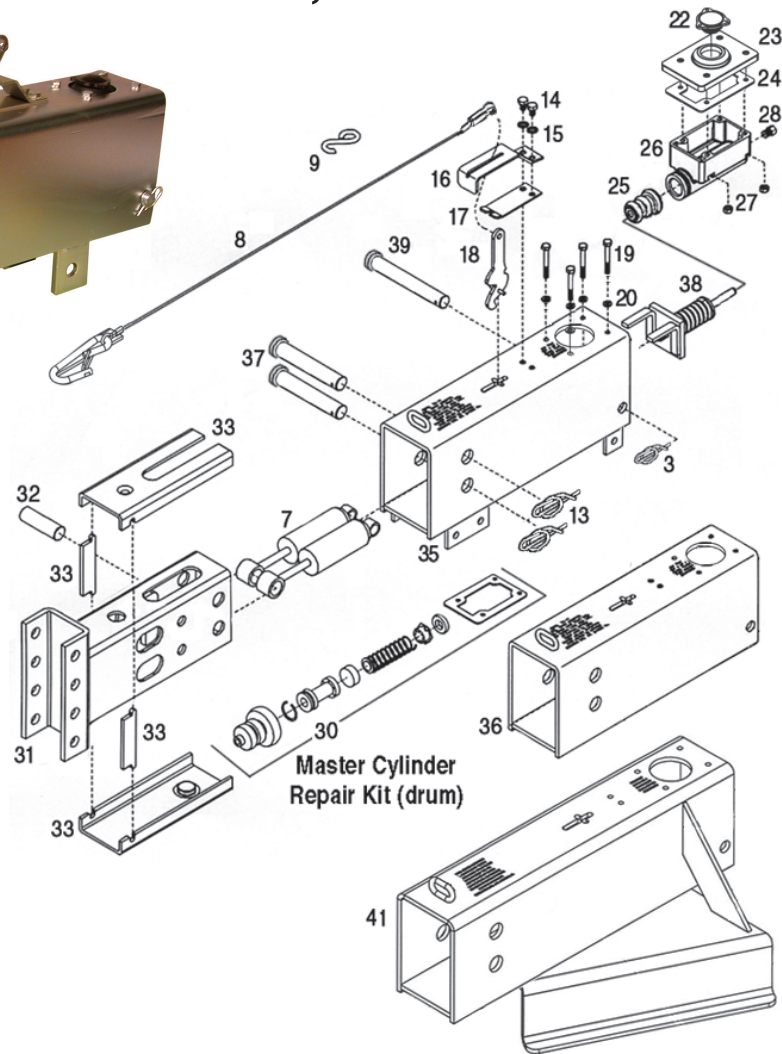

Ref. No.	Part No.	Description	Qty. Req.
1	11053-95	Centered clevis channel - zinc plated	1
1	11053-97	Centered clevis channel - primed	-
2	05973X	Front shock pin - zinc plated	1
3	12396	Rue ring lock, cotter pin for .63 pin	1
4	5943	Wear pad kit DA10	1
7	12426	Damper shock	2
8	05408X	3/32" Cable with hooks & yoke	1
9	10555	Actuator S-hook ONLY (old style)	-
10	11082X	Bolt on outer case - zinc plated	1
11	11068-97	Weld on outer case - primed	-
12	05986X	Connecting pin - zinc plated	2
13	12397	Rue ring lock, cotter pin for .88 pin	2
14	B5160625G5ZC	5/16"-18 x 5/8" Hex head bolt gr. 5	2
15	12489	5/16" External tooth lock washer	2
16	03866-95	Emergency lever guide - zinc plated	1
17	05693-95	Emergency lever spring - zinc plated	1
18	05951X	Emergency lever - zinc plated	1
19	B142G5ZC	1/4"-20 x 2" Hex head bolt gr. 5	4
20	LW14Z	1/4" Lock washer	4
21	05989X	Push rod	1
22	03876X	Master cylinder cap with diaphragm & O-ring	1
	05849X	O-ring only (not shown)	-
23	12557	Master cylinder cover plate	1

Ref. No.	Part No.	Description	Qty. Req.
24	17434	Replacement master cylinder gasket ONLY	-
25	05687X	Master cylinder protective boot	1
26	5672	Master cylinder with gasket for disc brakes (includes 19, 20, 22, 23, 24, 25, 27)	-
26	05680X	Master cylinder with gasket for drum brakes (includes 19, 20, 22, 23, 24, 25, 27)	1
27	HN14G5ZC	1/4"-20 Hex nut	4
28	05679X	1/8" Pipe-3/16" inverted flare fitting w/1/8" orifice	1
28	12098	1/8" Pipe-3/16" inverted flare fitting w/1/64" orifice	1
28	SB12099	1/8" Pipe-3/16" inverted flare fitting w/1/32" orifice	1
29	05974X	Rear shock pin-zinc plated	1
30	5398	Master cylinder repair kit for drum brakes	-
31	11049-97	12" Centered clevis channel - primed	1
31	11044-97	Centered clevis channel - primed	-
32	03409-95	Front shock pin - zinc plated	1
33	5944	Wear pad kit DA20	1
35	03548X	Bolt on outer case - zinc plated	1
36	03412-97	Weld on outer case - primed	-
37	03411-95	Connecting pin - zinc plated	2
38	03534X	Push rod	1
39	03410-95	Rear shock pin - zinc plated	1
40	11088-97	Outer case with 50° mount - primed DA10	1
41	03884-97	Outer case with 50° mount - primed DA20	1